

Varenummer: 0101081
 Beskrivelse: Seeger låsering A 68 DIN 471
 Fjederstål
 Note: Monteres med ZGA tang

Mål

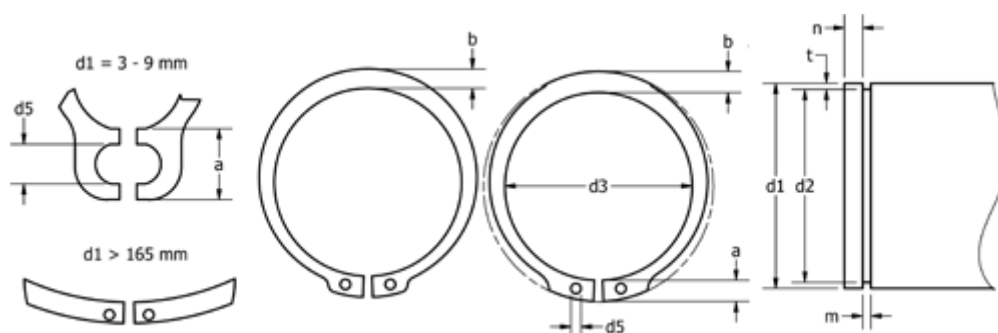

| | | | | | |
|--------------------|---------|--------------|----------|--------------|--------------|
| a max | = 8,0 | FN kN | = 52.2 | s | = 2.50 |
| AN mm ² | = 313.0 | FRg kN | = 23.10 | t | = 1.50 |
| b | = 6.5 | FR kN | = 135.00 | Tang | = ZGA-3 |
| Betegnelse | = A68 | g | = 2.5 | tol | = -0.07 |
| d1 | = 68 | K kN-mm | = 244.00 | tol | = +0,46-1,10 |
| d2 | = 65.0 | m min | = 2.65 | tol | = -0.30 |
| d3 | = 63.5 | n abl x 1000 | = 7.0 | vægt kg/1000 | = 21.800 |
| d5 min | = 3.0 | Nominel træk | = 4.5 | | |